

Spherical roller bearings, cylindrical and tapered bore

Principal dimensions			Basic load ratings		Speed ratings		Designation
d	D	B	dynamic C	static C0	Reference speed	Limiting speed	
mm			kN		r/min		
<b>140</b>	225	68	659	900	2200	2800	<b>* SKF Explorer bearing</b> 23128 CCK/W33 *

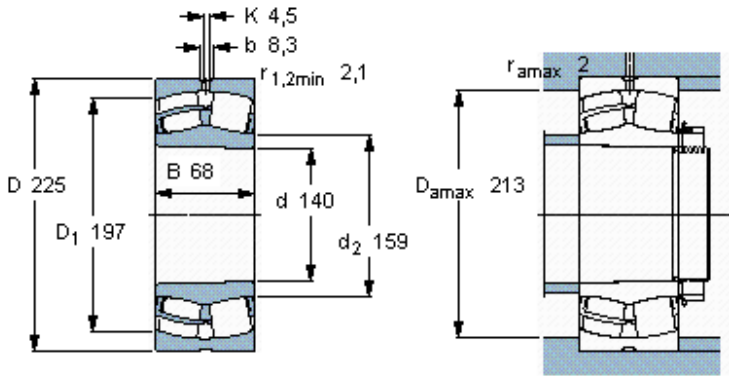

Tapered bore, taper  
1: 12

**Calculation factors**

- e 0,28
- $Y_1$  2,4
- $Y_2$  3,6
- $Y_0$  2,5